

BP 01
48" BUTLERS PANTRY

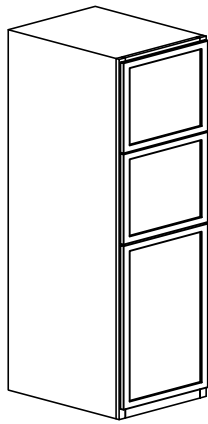

008
21" PANTRY

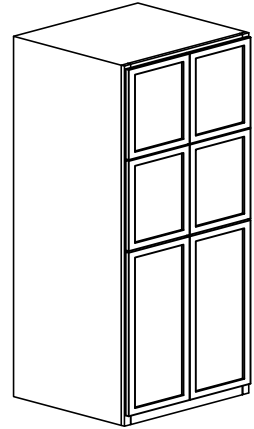

007
30" PANTRY (W/ LAZY SUSAN & SLIDER DRAWER)

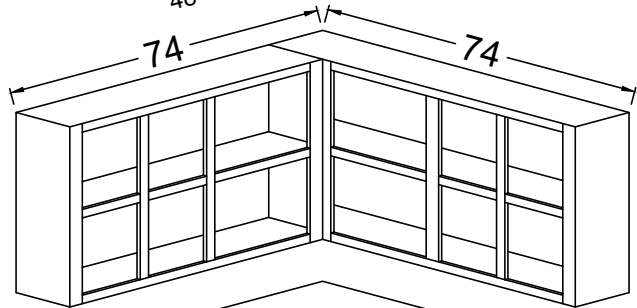

122
CORNER PANTRY

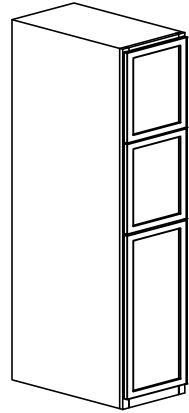

009
15" PANTRY

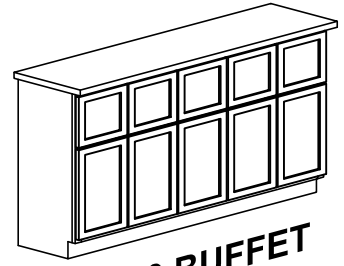

2460 BUFFET
60" BUFFET

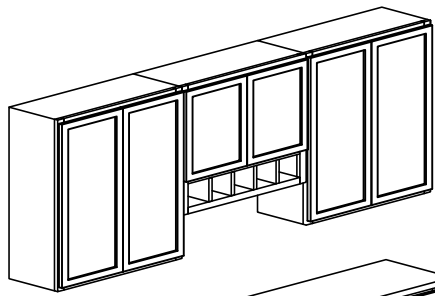

095
90" HUTCH

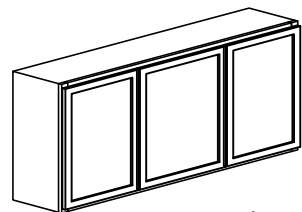

093
57" HUTCH

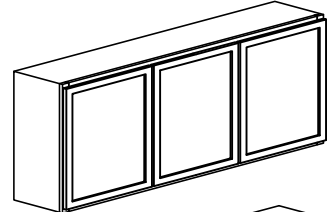

004
63" HUTCH

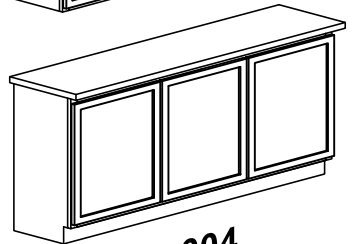
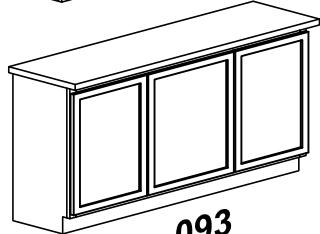
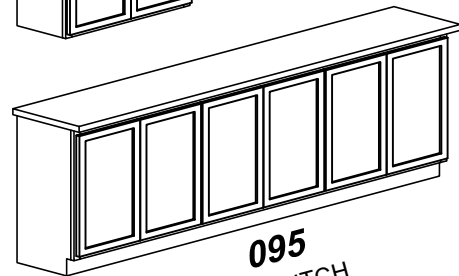

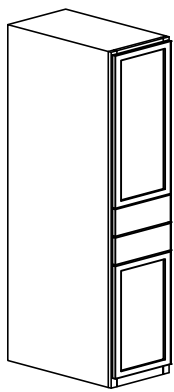

006
15" LINEN

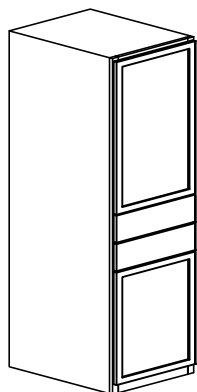

005
21" LINEN

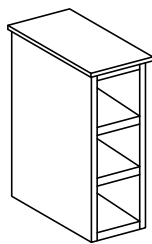

074
15" HALF STACK
LINEN

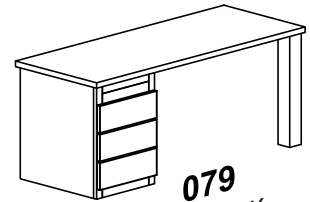
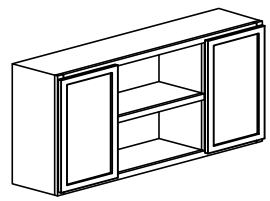

079
53" DESK

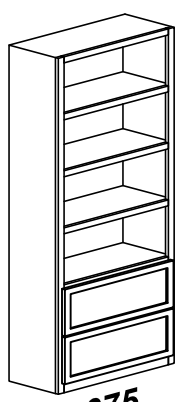

075
CLOSET
ORGANIZER

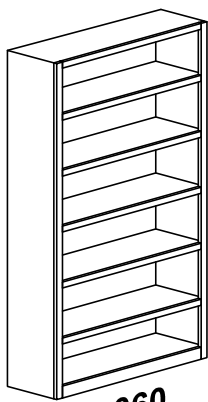

060
33" BOOK
CASE

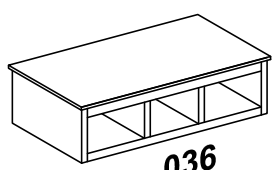

036
BENCH /
WINDOW SEAT

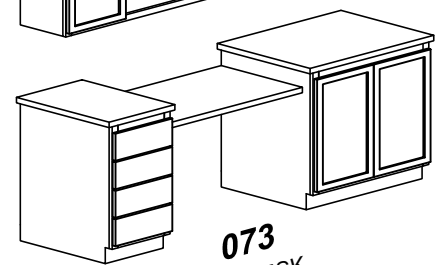
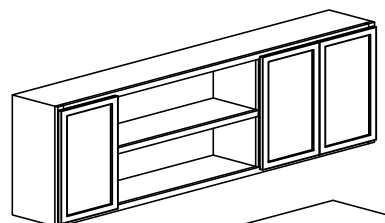

073
82" DESK

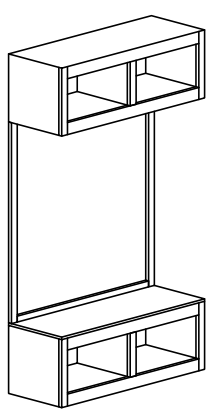

033
SMALL HALL TREE
WITH BENCH

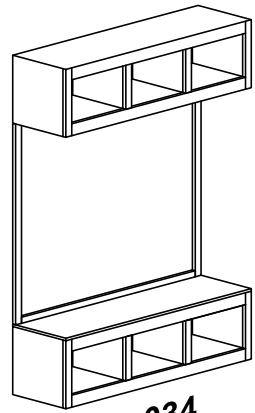

034
LARGE HALL TREE
WITH BENCH

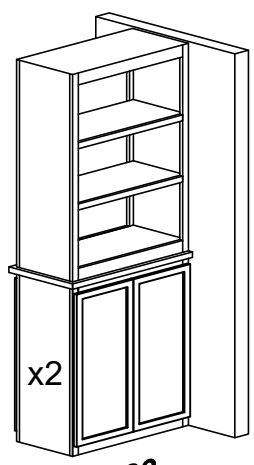

123
ROOM
DIVIDER
x2

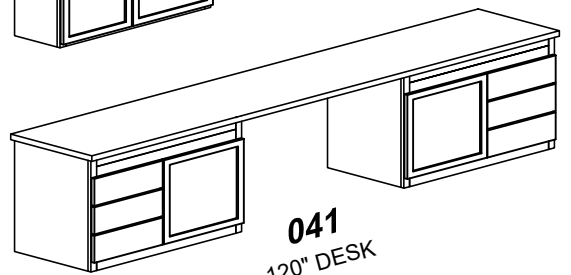
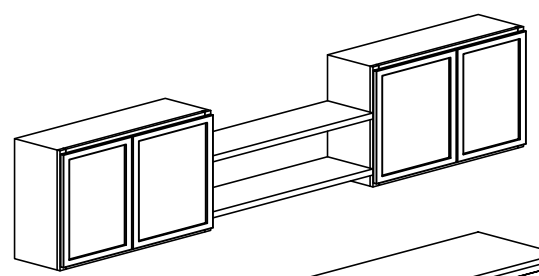

041
120" DESK

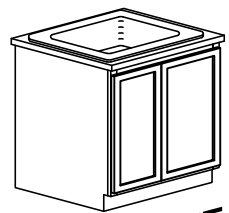

043 SMALL UT. SINK
27" UTILITY SINK

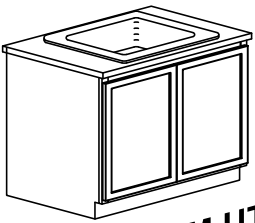
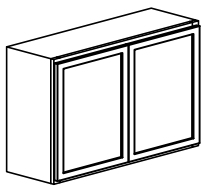

047 MEDIUM UT. SINK
36" UTILITY SINK W/ OH

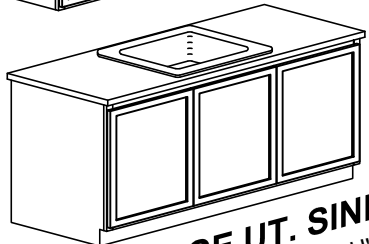
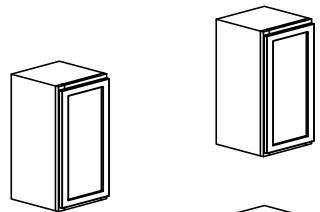

066 LARGE UT. SINK
63" UTILITY SINK W/ 12" OH'S

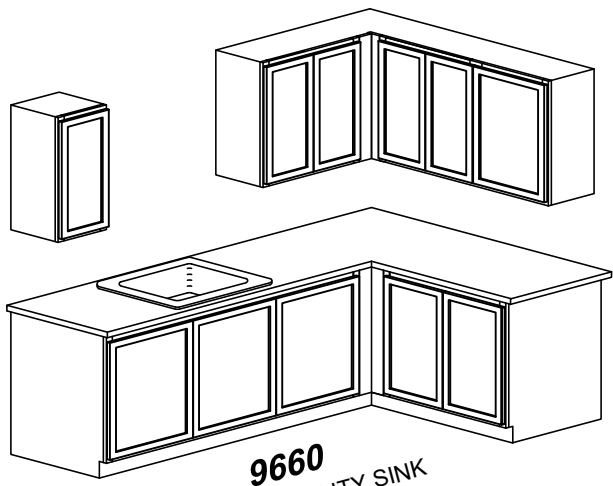

9660
"L" SHAPE UTILITY SINK
(SIZE VARIES)

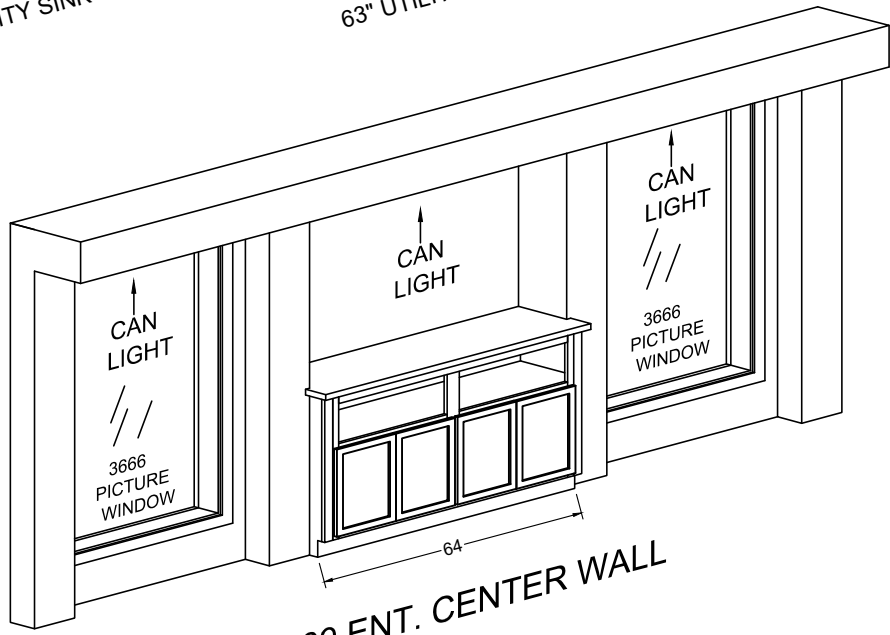

089 ENT. CENTER WALL

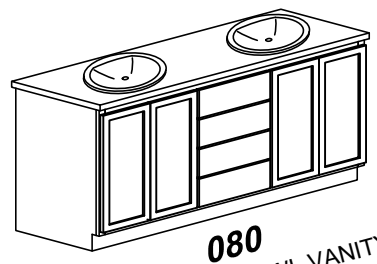

080
67" DOUBLE BOWL VANITY
(CRS REQUIRED)

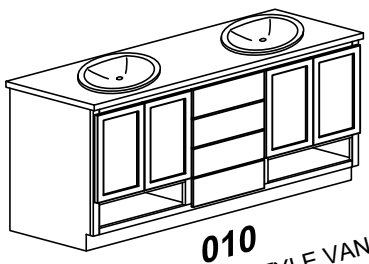

010
67" FURNITURE STYLE VANITY
(CRS REQUIRED)

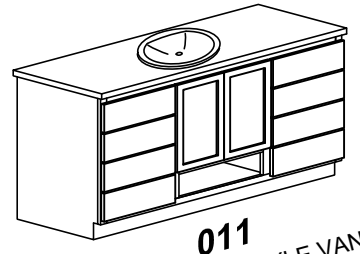

011
60" FURNITURE STYLE VANITY
(CRS REQUIRED)

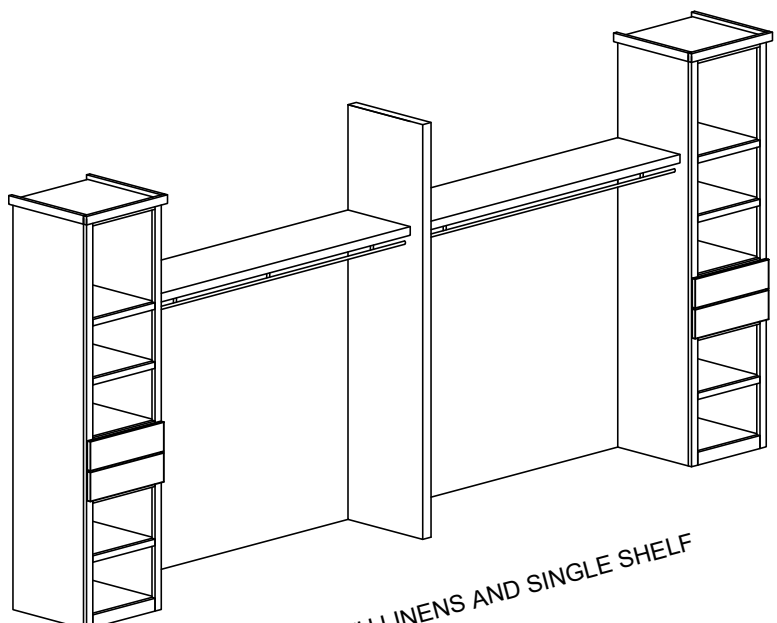

WALL #1 WITH LINENS AND SINGLE SHELF

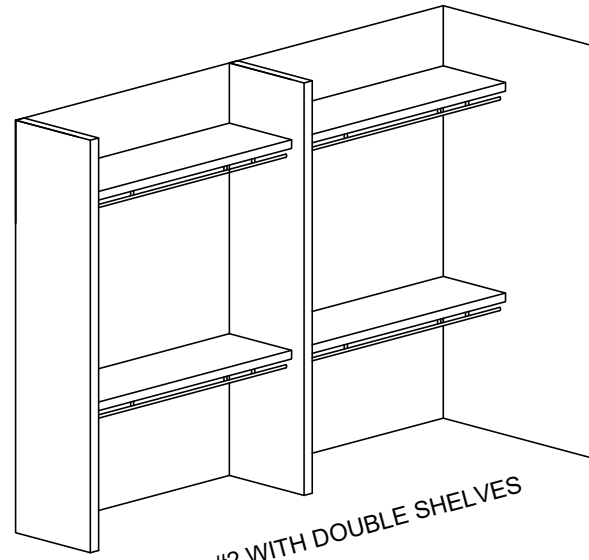

WALL #2 WITH DOUBLE SHELVES

FULL CLOSET ORGANIZER
DESIGN VARIES BY FLOOR PLAN
(CRS REQUIRED)

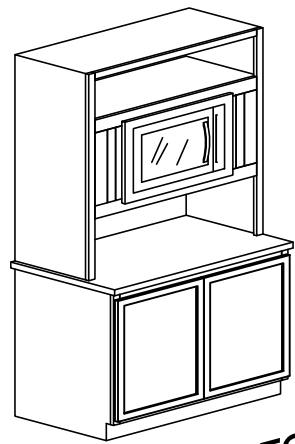

WINSTON HUTCH
AVAILABLE IN 3272H/M32186

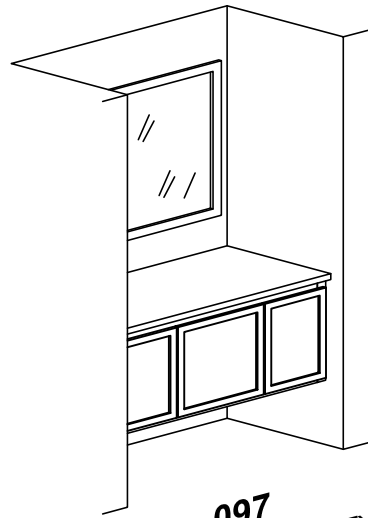

097
52" FLOATING VANITY
W/ MIRROR