

*Gas Only*

STONE SURROUNDS WILL BE DIFFERENT THAN STONE SHOWN IN ILLUSTRATIONS

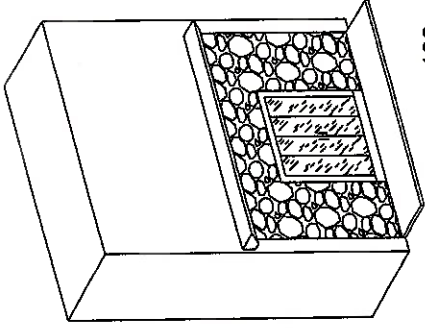

102  
STANDARD FIREPLACE  
w/ 1/2 STONE SURROUND

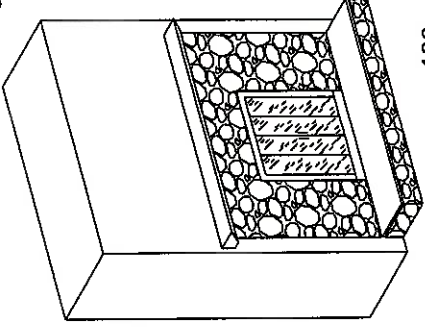

103  
RAISED HEARTH FIREPLACE  
w/ 1/2 STONE SURROUND

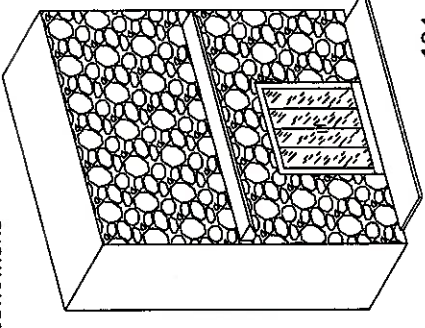

104  
STANDARD FIREPLACE  
w/ FULL STONE SURROUND

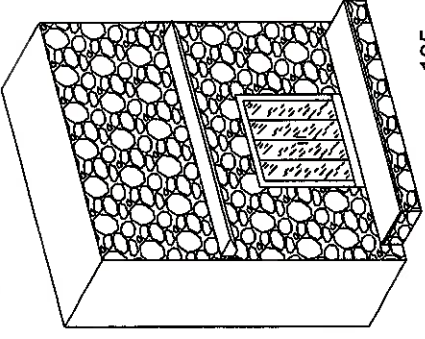

105  
RAISED HEARTH FIREPLACE  
w/ FULL STONE SURROUND

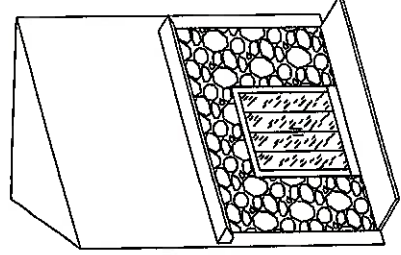

106  
CORNER STANDARD FIREPLACE  
w/ 1/2 STONE SURROUND

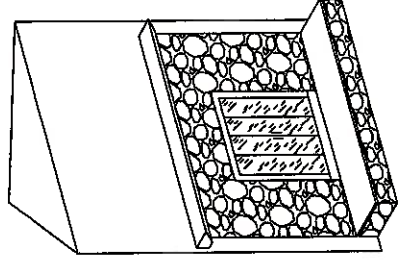

107  
CORNER RAISED HEARTH FIREPLACE  
w/ 1/2 STONE SURROUND

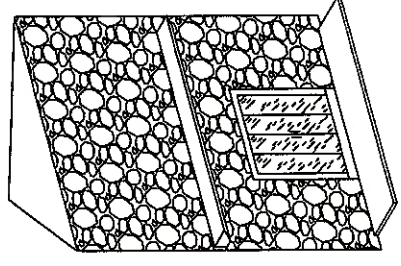

108  
CORNER STANDARD FIREPLACE  
w/ FULL STONE SURROUND

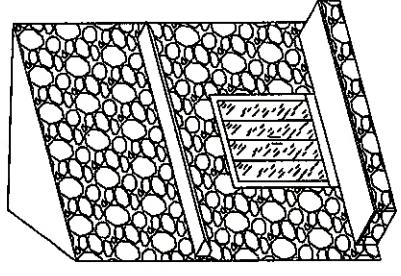

109  
CORNER RAISED HEARTH FIREPLACE  
w/ FULL STONE SURROUND

**CHAMPION**  
308 SHERIDAN DRIVE TOPEKA, IN 46571

APPROVER'S SEAL

MODIFICATIONS	
1	REMOVED CATHEDRAL WALLS JMD 09-15-15
2	ADDED PANORAMIC FP'S JMD 01-29-18
3	ADDED 164 ENT CTR. REMOVED 162 JMD 02-19-18
4	MOVED STONE FP TO ONE PAGE TWC 02-11-21

PROPRIETARY AND CONFIDENTIAL  
THESE DRAWINGS AND SPECIFICATIONS ARE ORIGINAL  
PROPRIETARY AND CONFIDENTIAL MATERIALS OF CHAMPION  
COPYRIGHT © 1976-2008 BY CHAMPION

MODEL: FIREPLACE OPTIONS  
REDMAN/DUTCHFORTUNE/COMMANDER

TITLE: FIREPLACE OPTIONS

AP-102

SHEET:

DRAWN BY: B. CampBell DATE: 08-27-11

SCALE: 1/8" = 1'-0"

REV. D

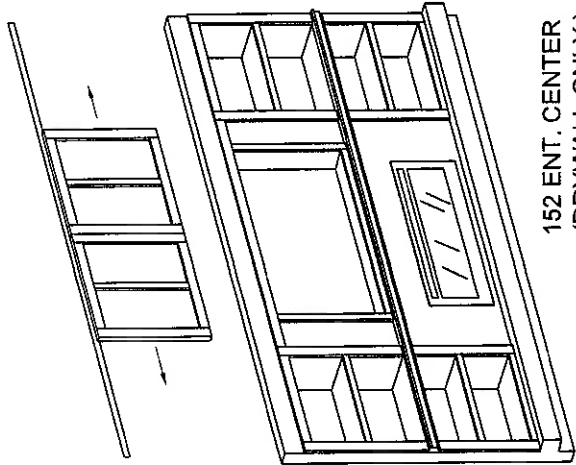

152 ENT. CENTER  
(DRYWALL ONLY)  
(INCLUDES PANORAMIC FIREPLACE)

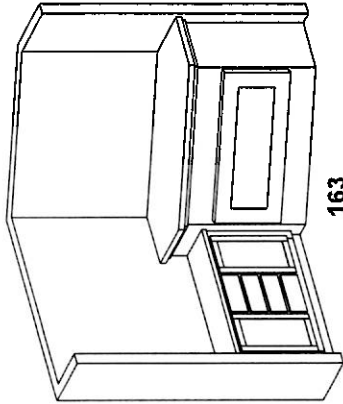

163  
ELECTRIC FIREPLACE/HUTCH  
INCLUDES PANORAMIC FIREPLACE

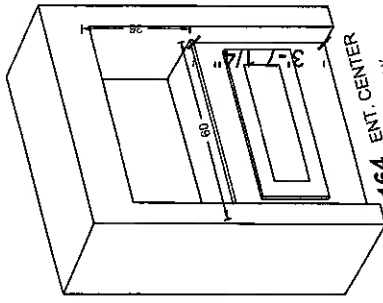

164 ENT. CENTER  
DRYWALL ONLY  
INCLUDES PANORAMIC FIREPLACE

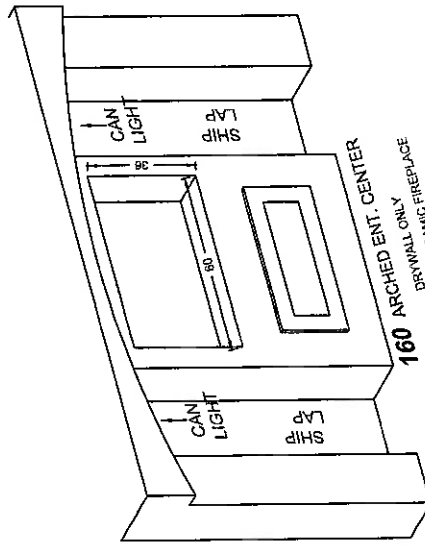

160 ARCHED ENT. CENTER  
DRYWALL ONLY  
INCLUDES PANORAMIC FIREPLACE

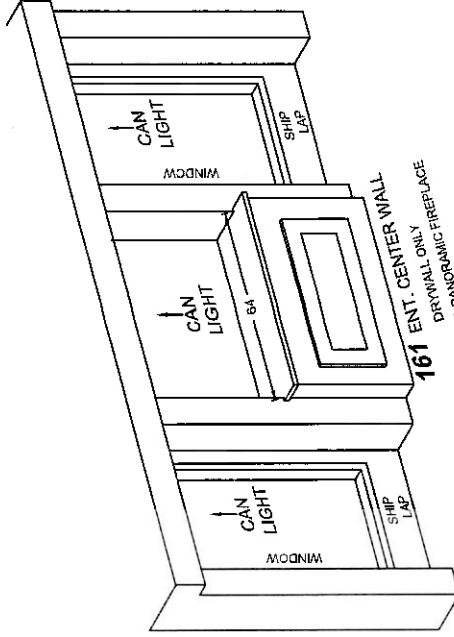

161 ENT. CENTER WALL  
DRYWALL ONLY  
INCLUDES PANORAMIC FIREPLACE

APPROVER'S SEAL

MODIFICATIONS

2	OMIT CERAMIC	JMD	01-29-18
3	ADDED 151 ENT. CENTER	--	01-17-19
4	ADDED 152 ENT. CENTER	TWC	11-21-19
5	REMOVED DW FIREPLACES	TWC	02-11-21

PROPRIETARY AND CONFIDENTIAL  
THESE DRAWINGS AND SPECIFICATIONS ARE ORIGINAL  
PROPRIETARY AND CONFIDENTIAL MATERIALS OF CHAMPION.  
COPYRIGHT © 1976-2008 BY CHAMPION

MODEL: FIREPLACE OPTIONS  
REDMAN/HUTCH/FORTUNE/COMMANDER

SHEET:

**CHAMPION**

308 SHERIDAN DRIVE TOPEKA, IN. 46571

TITLE: FIREPLACE OPTIONS

AP-101

DRAWN BY: B.CampBelli

DATE: 09-27-11

SCALE: 1/8" = 1'-0"

REV. E